

Quantitative Analysis of Corrosion Resistance for Electroless Ni-P Plating

Dr. Lei Jin, Dr. Jun Nable, Dr. Kesheng Feng, Lenora Toscano, Dr. Ernie Long

**Electronics Solutions, MacDermid, Inc.
227 Freight Street, Waterbury, CT 06702**

Abstract:

An electroless nickel (EN) layer is frequently used in various industrial applications. Commonly it is used as the barrier layer in electroless nickel/immersion gold (ENIG) as a solderability preservative for the electronics industry. The finish provides excellent corrosion resistance and good solderability. A shortcoming of this process is the potential for a hyperactive corrosion of the nickel surface during immersion gold plating. The resultant defect displays itself as a gray or black appearance at the nickel/gold interface, known as “Black Pad” or “Black Line Nickel”. It is important to determine and control the corrosion properties of an EN deposit during an ENIG process to obtain high quality products. Unfortunately, quantitative analysis of corrosion resistance of the EN layer has not been established in the field of PCB. In this paper, an electrochemical method via sequential electrochemical reduction analysis (SERA) instrument to quantify the corrosion resistance of the EN deposit is proposed. The data obtained via the electrochemical method was analyzed and correlated to the deposit properties of the EN. The method is easy to use and can be applied for quantitative analysis in industrial EN processes.

1. Introduction:

Solderability preservatives are critical for successful manufacture of electronics. The surface finish protects copper circuitry from oxidation prior to assembly to ensure strong contact can be made between the PCB and the components. The final finish step is critical because if there are quality issues at this stage in manufacture, many times they can go undetected until after product build. Post assembly detection of black line nickel results in very expensive scrap that cannot be recovered.

Ultimately, the EN acts as a barrier layer between copper and the precious metal top layer such as gold or palladium. Copper will readily migrate through a gold deposit, oxidize and then render the finish unsolderable. So, the nickel layer is essential to the performance of the surface finish and in turn the corrosion resistance of that electroless nickel (EN) coating is a very important characteristic. By definition, immersion gold can only plate as a result of some nickel corrosion. So there must be a fine balance maintained to ensure enough gold deposition without excessive nickel corrosion. In addition to corrosion resistance to the gold plating electrolyte, the electroless nickel layer must maintain corrosion resistance to environmental exposure. Both as a barrier layer and an environmentally resistant coating, EN containing final finishes offer the highest performance of the lead free alternative surface finishes [1,3,4,7] currently on the market.

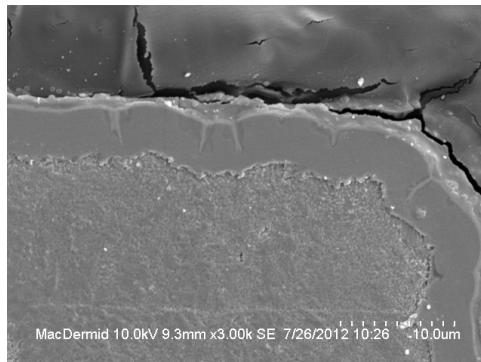

Figure 1. Typical Black Line Nickel (BLN) after ENIG.

Current techniques to measure the corrosion resistance of EN are mostly limited to qualitative methods such as nitric acid dip testing. The subjective approach of these methods leaves room for different interpretations. In this paper we present a simple approach to quantitatively compare the corrosion resistance of an EN deposit by using Sequential Electrochemical Reduction Analysis (SERA).

SERA is a technique primarily used to analyze both metal and metal oxide thickness using reduction or an oxidation reaction. The measured electrochemical potential is plotted against the analysis time at a given applied current density. Through Faraday's law, the metal or surface oxide thickness can be quantified. Different materials correspond to specific electrochemical potentials hence the shape of the plot gives information as to the nature and quality of the surface being analyze.

2. Experiments:

Initially, an electrolyte at pH 3.5 KCl (2M) solution buffered with sodium acetate was tested. The electrolyte was purged with nitrogen (N_2) at room temperature (RT). Scheme 1 is a schematic diagram of the SERA measurements on printed circuit boards. The part to be analyzed is brought in contact with a KCl electrolyte by o-rings (1.6 mm) that forms a seal around the top and bottom of the PCB board. A current density of $+500 \text{ uA/cm}^2$ is applied for 30 seconds prior to analysis to remove nickel surface passivation. The current density is then set to -1000 uA/cm^2 for 90 seconds to corrode the nickel surface. The SERA corrosion pattern along with the potential E (v) at 90 seconds is recorded. A more detailed explanation of the SERA principles can be found as reported in pervious literatures citations [2,5,6].

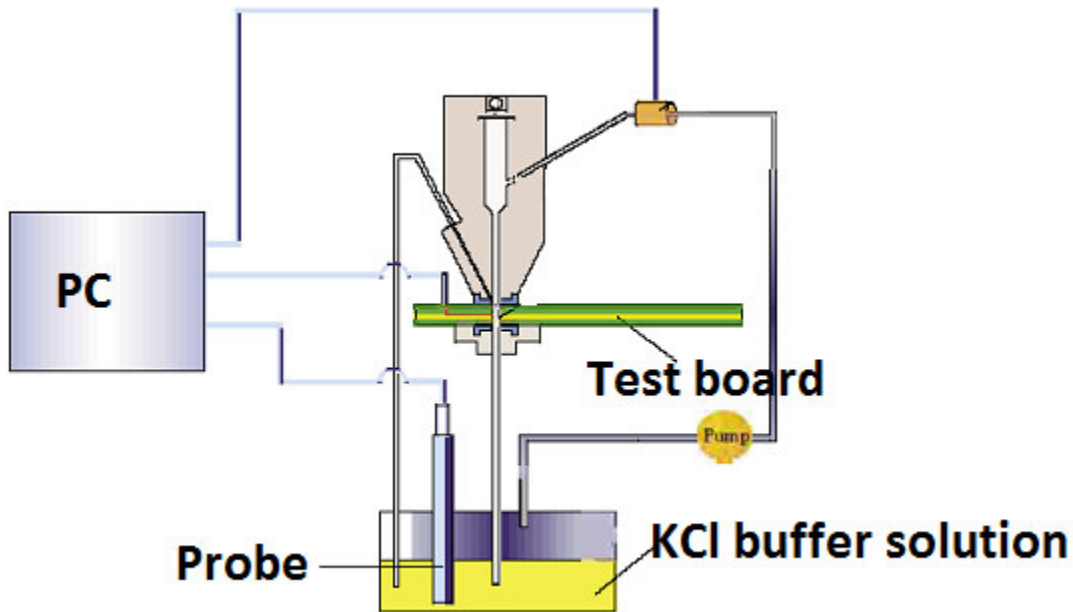

Scheme 1. Schematic representations of SERA test equipment.

3. Results and Discussion

3.1 Determining suitable electrolytes.

It was found that different electrolytes with varying pH and concentration of Cl⁻ played a role in the resolution of nickel surface corrosion. Three commercial EN products with surface corrosion resistance range from low to high were used to determine the suitable electrolytes and reliability of this method. The samples were determined by a proprietary wet chemical method to have different weight percentages of phosphorous (wt. %P) levels namely 7, 9 and 11.

First, we compared these 3 different EN samples using a 0.2 M HCl electrolyte solution adjusted with KOH to pH 4.0. As shown in Figure 2, the sample with the lowest corrosion resistance (7wt. %P) showed a

significant drop in potential, decreasing by more than 0.2 V, between the 15 and 45 second mark whereas the 9 wt. %P sample only decreased by less than 0.15 V within the same time interval. The sample with the highest corrosion resistance (11wt. %P) showed the highest corrosion potential and did not show any significant changes in potential during the entire measurement. The experiment was then repeated with an electrolyte prepared with a 2 M KCl and 15 g/L NaAc solution adjusted to pH 3.5 with HAc. The shapes of the corrosion plots are different compared to those shown in Figure 3. The highest corrosion resistant sample remained steady at close to 0.58 V throughout the corrosion test whereas the 9 wt. %P sample was steady at 0.18 V and the lowest corrosion resistant sample with 7wt. %P EN bottomed at 0.05 V, indicating better resolution than the test using the 0.2 M electrolyte solution. As a result of this work, the latter electrolyte was selected for all tests.

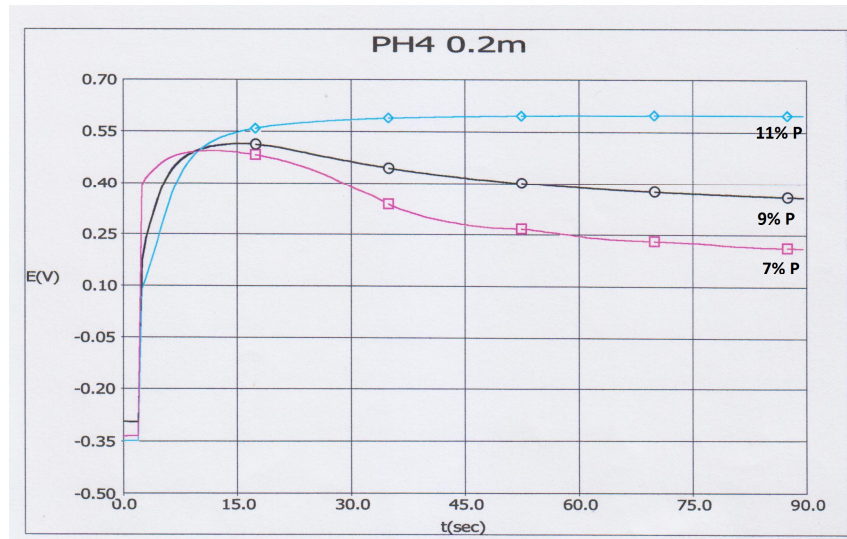

Figure 2. SERA corrosion test comparing 7, 9 and 11 wt% P EN surfaces with 0.2 M HCl at pH 4.0



Figure 3. SERA corrosion test comparing 7, 9 and 11 wt. %P EN surfaces with 2 M KCl,

3.2 Reliability

The proposed method to determine EN surface corrosion resistance is reliable. As shown previously with a different electrolyte the relative order of the corrosion plots depending on the corrosion resistance of the EN samples remained the same. The highest corrosion resistance, corresponding to the higher wt. %P

sample, tends to have a higher potential measurement compared to a lower corrosion resistance EN sample. The relative order of the corrosion plots of the samples can be a useful tool to compare the wt. %P in the EN deposits (within the same EN plating bath), and therefore, the corrosion behavior.

In order to further prove the statement, we ran a commercial EN bath (M-2, 7~8 wt. % P) to 6 metal-turn-overs (MTO) and collected the plated PCB samples at every 0.5 MTO for wt. %P and corrosion resistance test using the SERA method. Figure 4 shows the trends of both P% and SERA potential throughout the bath life. It can be seen that wt. %P and SERA oxidation potential had the same response to the bath life. It is well known that within the same EN product, the higher the wt. % P, the better the corrosion resistance for the EN deposit, and this match indicates very good reliability of the proposed method.

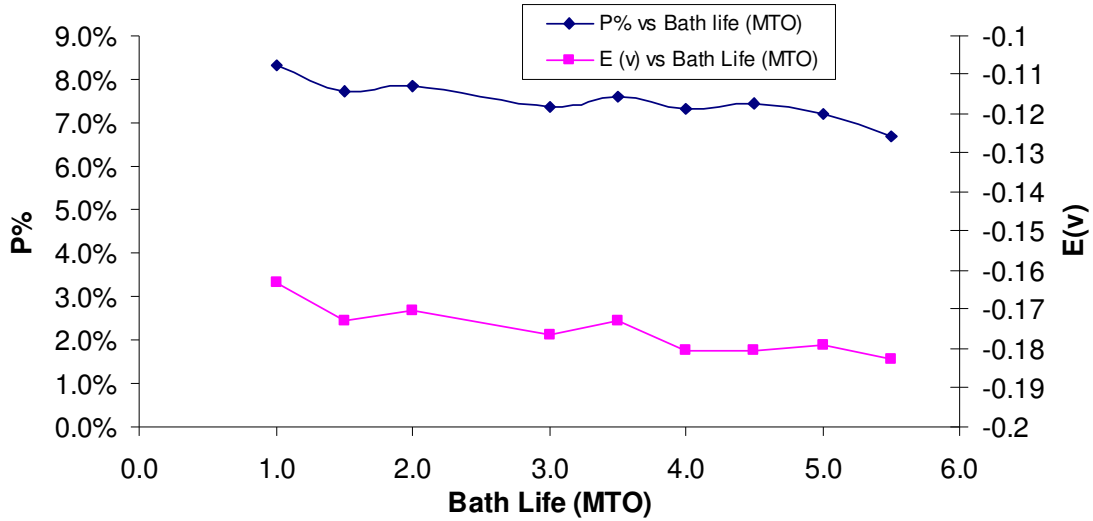

Figure 4. Comparison of wt. %P with SERA results at different bath life. The E(v)s are the oxidation potential after 90s corrosion. Commercial available EN bath (M-2) was used for this experiment.

It is very interesting that when the E(v) is plotted as a function of wt. %P throughout the bath life, a linear relationship between wt. %P and oxidation potential after 90s corrosion was found. As shown in Figure 5, a $R^2=0.97$ was obtained for the linear plot. This is additional evidence showing good reliability of this SERA method for EN corrosion resistance test. When it is calibrated with the linear relationship, one can even determine wt. %P at different spots of PCB board within the same EN bath. Compared with conventional wet methods to determine wt. %P, which are complicated and time consuming, this application is relatively simple and straight forward.

As indicated above, this method can be a useful tool to help compare and quantify the corrosion behavior of EN deposits. In order to get accurate results, there is one key factor that has to be monitored closely. That is the EN surface potential for passivation. This thin oxide layer is not standardized in all samples and will likely interfere with the anodic reaction of the measurement. To limit this interference and minimize the variance caused by the oxidized surface, a cathodic current is first applied as a pretreatment to reduce the passivated layer. Once the passivated layer has been reduced, an anodic current is then applied to start the corrosion experiment. Thus, before an EN SERA corrosion experiment, it is suggested to run an initial $+500 \text{ uA/cm}^2$ current density for about 30 seconds to reduce the passivated layer. This step ensures a more normalized EN surface prior to the corrosion test. The corrosion measurement is then started using a -1000 uA/cm^2 current density on a 0.0201 cm^2 sample area. The corrosion time should be set high enough to distinguish the EN surfaces. The type of electrolyte used is also important as it will affect the corrosion behavior of the surface as previously presented.

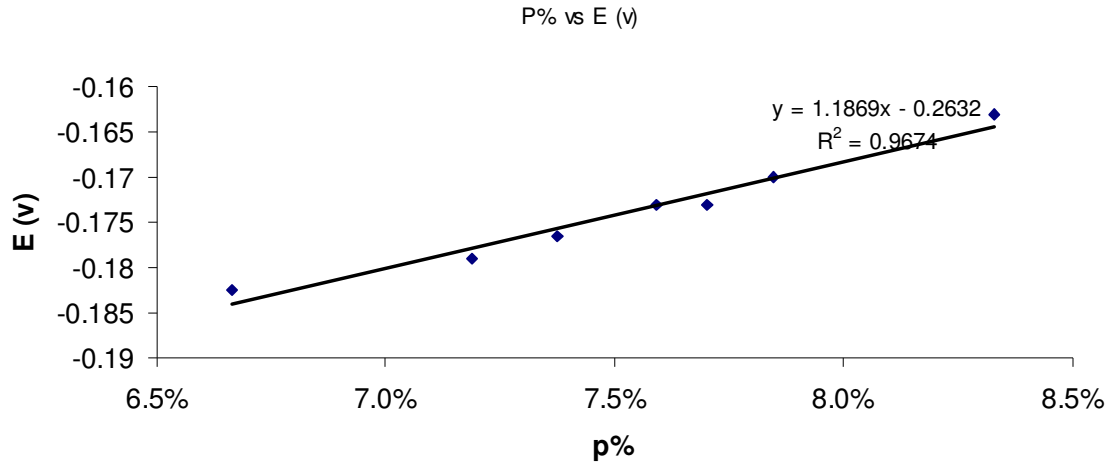

Figure 5. Plot of oxidation potential (E) after 90s corrosion as function of P% in EN deposit.

4. Applications of the proposed method.

4.1 Quality Control Application

This method can also be used as a simple quality control technique during EN plating. As shown in the following example, two commercial available EN baths (M and U) with a targeted 8 wt. %P were aged to several metal-turn-overs (MTO). Several samples were plated at different MTO intervals of the bath. When the corrosion resistance was measured with this technique, the corrosion plots shown in Figure 6a indicate very consistent corrosion resistance behavior at these MTOs (commercial M electroless nickel product), whereas the corrosion behavior of commercial U product (shown in Fig. 6b) showed variations throughout the bath life. These results display the better quality of EN deposit obtained from M product than the one from U product.

Regarding quality control of EN products, another very important parameter is the uniformity of the EN deposit on PCB boards. In some cases, the corrosion of EN deposit on small pads behaves differently than large pad designs on the same PCB board. Here we choose a popular commercial available EN bath (U product) to test its uniformity of deposit on a test board. The board was plated in the EN bath for 20 minutes to plate about a 200 μm nickel deposit. As marked in figure 7a, 3 points were chosen for the SERA corrosion test. The results (figure 7b) showed that the large pad (point 1) had a better corrosion resistance property while the small pads (point 2, and 3) showed dropped oxidation potential, indicating worse corrosion resistance. This indicates a poor uniformity of the EN deposit on the test board and the proposed method provides straight forward evidence for the quality of this commercial EN product.

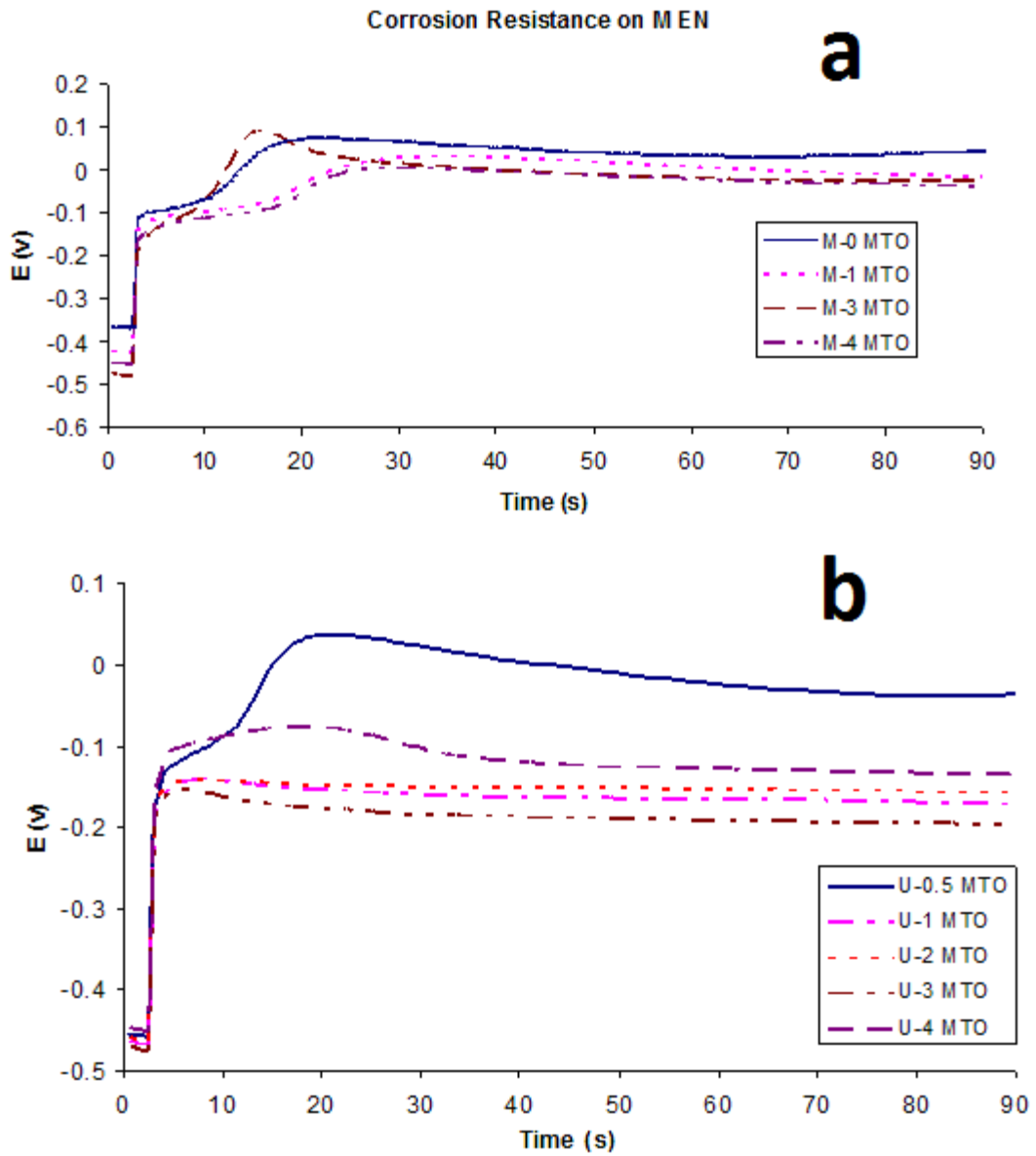

Figure 6. Corrosion plot at different EN MTO interval

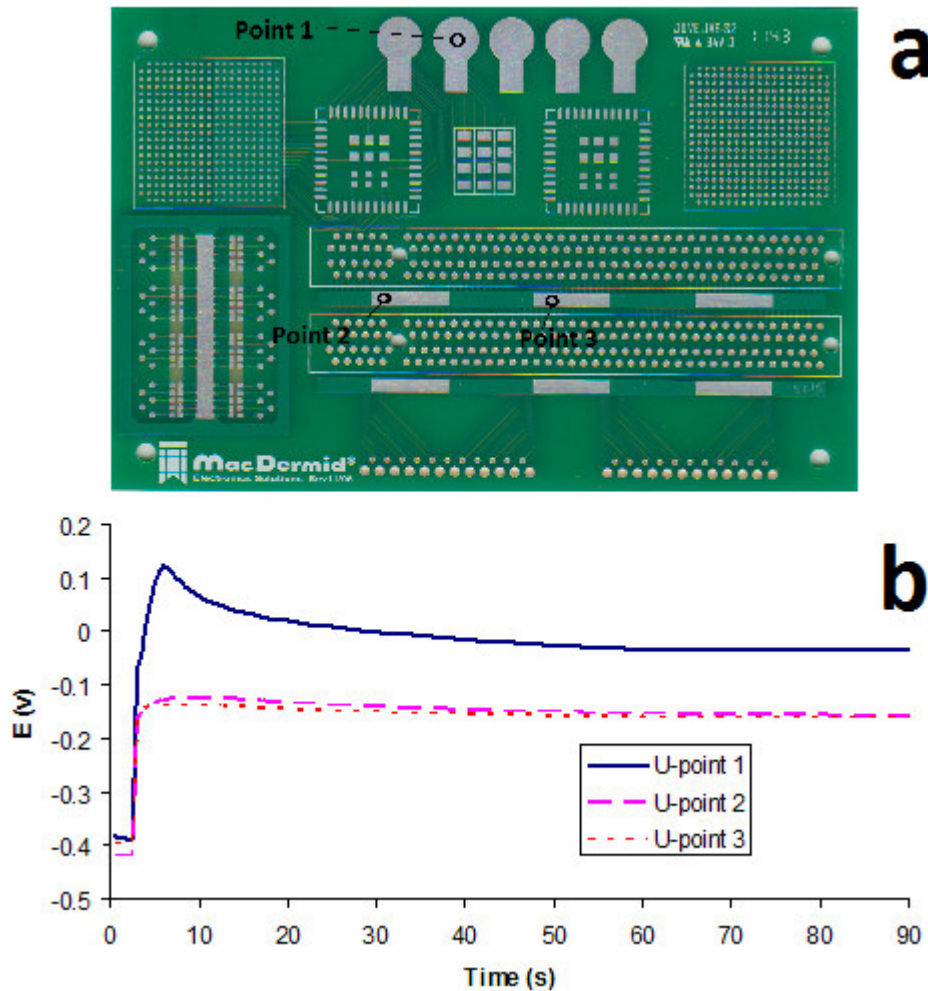

Figure 7. Corrosion resistance behavior of different areas on a PCB test board.

4.2 Corrosion Behavior Comparison for Different EN products

Since most EN products are unique and have different corrosion behavior, the SERA technique can be used as a fast and simple method to differentiate these EN deposits. As shown in Figure 8, three different EN formulations with similar wt. %P content yielded different corrosion plots, indicating different corrosion behavior even though the P content of these three commercial products are very similar. It is believed that not only P content, but percent sulfur (S%), surface morphology, and some other factors play a role in corrosion resistance. Conventional nitric acid (HNO_3) testing can only give a subjective, inaccurate response that is difficult to interpret. The corrosion behavior and results obtained from HNO_3 dip test can be inconsistent. The proposed method, however, can quantitatively record the corrosion behavior for different EN deposits.

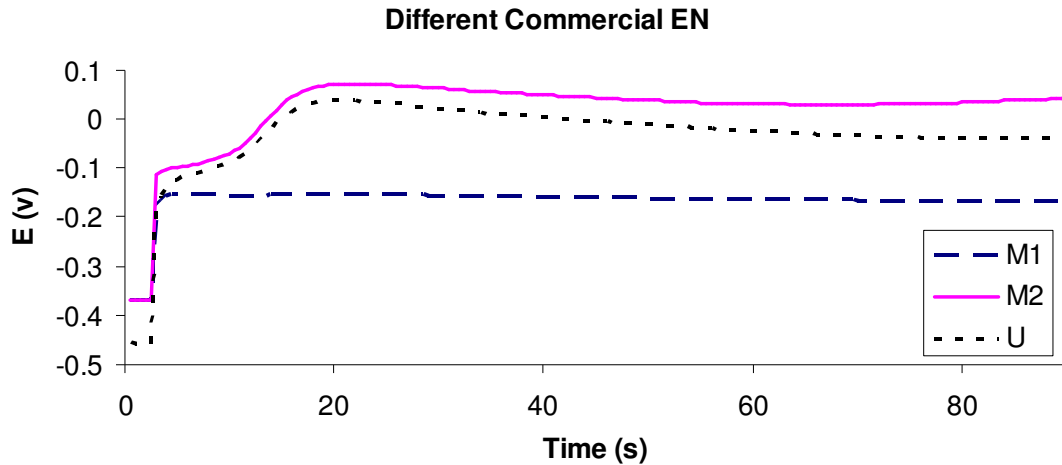

Figure 8. Comparing different commercial EN deposit.

4.3 Formulations Comparison

Currently researchers are still paying strong attention to electroless nickel formulation improvement to mitigate “black pad” or “black line nickel” issues. The corrosion behavior is one of the most important parameters to determine the potential behavior regarding the black pad issues. This SERA method provides a very useful tool to screen EN deposits with different formulations. Figure 9 shows an example of corrosion behaviors which result when the S stabilizer concentrations are varied in the electroless nickel formulation. It was suggested that the lower the concentration of S stabilizer used in the bath, the higher corrosion resistance the obtained EN deposit can have. This statement is proved now by using the proposed SERA method as seen in figure 9. The lower concentration of S stabilizer used in the bath, the higher the oxidation potential obtained from SERA, indicating highest corrosion resistance properties. As the concentration of S stabilizer increases, the oxidation potential drops and it follows the same order. Thus, this new method provides a direct, efficient, quantitative, and straight forward tool for EN researchers.

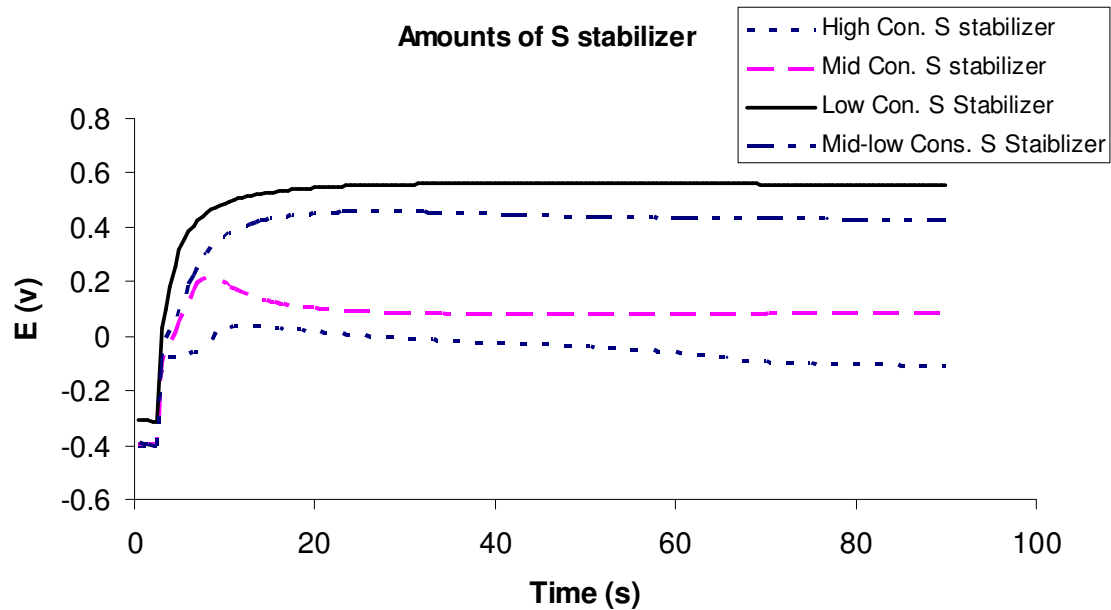

Figure 9. Results of different corrosion behavior of EN deposit with different concentration of S stabilizer in EN bath.

5. Conclusion

Results presented here show that the new SERA test method can be applied on a routine basis to assess the corrosion resistance behavior of EN deposit. This method is a relatively simple, fast, and quantitative analysis. Within the same EN bath, this method can even be used to determine P% at different points on a PCB boards. This proposed method can also be applied on other applications, such as EN quality control, product screening, and formulation comparisons on a simple and quantitative basis.

Acknowledgement:

We would like to acknowledge Mr. Lev Taytsas (R&D Central, MacDermid Electronics Solutions) for his help with setup of the SERA equipment and many thanks to Ms. Wei Yan (Final Finishing, MacDermid Electronics Solutions) for her help in running EN baths and collecting data.

References:

- [1] D. Beckett, Operational experience using an organically stabiliser electroless nickel., Proceedings - AESF SUR/FIN Annual International Technical Conference. (2008) 14–24.
- [2] P. Bratin, M. Pavlov, G. Chalut, R. Gluzman, New application of the SERA method-assessment of the protective effectiveness of organic solderability preservatives., Proceedings of the AESF Annual Technical Conference. 82nd (1995) 583–589.
- [3] Y. Liu, D. Beckett, D. Hawthorne, Effect of heat treatment, top coatings and conversion coatings on the corrosion properties of black electroless Ni-P films., Applied Surface Science. 257 (2011) 4486–4494.
- [4] N. Micyus, Corrosion resistance of ELV-compliant mid- and low/mid- phosphorus electroless nickel., Proceedings - AESF SUR/FIN Annual International Technical Conference. (2008) 1–13.
- [5] D.M. Tench, D.P. Anderson, Electrochemical assessment of tin-lead solderability., Plating and Surface Finishing. 77 (1990) 44–46.
- [6] D.M. Tench, M.W. Kendig, D.P. Anderson, D.D. Hillman, G.K. Lucey, T.J. Gher, Production validation of SERA solderability test method., Soldering & Surface Mount Technology. 13 (1993) 46–50.
- [7] L.M. Toscano, E. Long, W. Paw, D.M. Kologe, K. Koyasu, K. Nishu, Method for treating metal surfaces useful for electronic packaging applications., 2012.